

## Basic Characteristics Data

Model	Circuit method	Switching frequency [kHz]	Input current [A]	Rated input fuse	Inrush current protection circuit	PCB/Pattern			Series/Parallel operation availability	
						Material	Single sided	Double sided	Series operation	Parallel operation
PJA100F	Active filter	40 to 160	1.2 *1	250V 3.15A	Thermistor	FR-4		Yes	Yes	No
	Flyback converter	20 to 150 *2								
PJA150F	Active filter	40 to 160	1.7 *1	250V 4A	Thermistor	FR-4		Yes	Yes	No
	Flyback converter	20 to 150 *2								
PJA300F	Active filter	60	3.9 *3	250V 10A	Thermistor	FR-4		Yes	Yes	No
	Forward converter	140								
PJA600F	Active filter	60	7.5 *3	250V 16A	SCR	FR-4		Yes	Yes	*4
	Forward converter	220								
PJA1000F	Active filter	65	12.5 *1	250V 20A	TRIAC	FR-4		Yes	Yes	No
	Forward converter	210								
PJA1500F	Active filter	65	18.0 *1	250V 30A	TRIAC	FR-4		Yes	Yes	No
	Forward converter	210								

\*1 The input current shown is at ACIN 100V and 90% load.

\*2 The burst mode frequency varies according to the operating conditions. Consult us for more details.

\*3 The input current shown is at ACIN 100V and 100% load.

\*4 Parallel operation is possible with -W option. see "5.Option and Other" in Instruction Manual.

<b>1</b>	<b>Function</b>	PJA-16
	1.1 Input Voltage Range .....	PJA-16
	1.2 Inrush Current Limiting .....	PJA-16
	1.3 Overcurrent Protection .....	PJA-16
	1.4 Overvoltage Protection .....	PJA-16
	1.5 Thermal Protection .....	PJA-16
	1.6 Output Ripple and Ripple Noise .....	PJA-17
	1.7 Output Voltage Adjustment .....	PJA-17
	1.8 Isolation .....	PJA-17
	1.9 Low Power Consumption .....	PJA-17
	1.10 Remote ON/OFF .....	PJA-17
	1.11 Remote Sensing .....	PJA-17
	1.12 LV Alarm .....	PJA-17
<b>2</b>	<b>Series Operation and Parallel Operation</b>	PJA-18
	2.1 Series Operation .....	PJA-18
	2.2 Parallel Operation .....	PJA-18
<b>3</b>	<b>Assembling and Installation Method</b>	PJA-18
	3.1 Installation Method .....	PJA-18
	3.2 Derating .....	PJA-19
	3.3 Expected Life and Warranty .....	PJA-20
<b>4</b>	<b>Ground</b>	PJA-21
<b>5</b>	<b>Options and Others</b>	PJA-21
	5.1 Outline of Options .....	PJA-21
	5.2 Others .....	PJA-26

# 1 Function

## 1.1 Input Voltage Range

- The rated input voltage range of the power supply is AC85-264V (See SPECIFICATIONS for more details).
- To comply with the safety standards, use the power supply with the input voltage range of AC100-240V (50/60Hz).
- If the input voltage is outside the rated range, the power supply may not operate in accordance with the specifications and/or start hunting or fail.
- If the input voltage changes suddenly, the output voltage may go out of the specifications. Consult us for more details.

### ● PJA100F, PJA150F

- If the input voltage is more than AC250V, power factor correction does not work and the power factor deteriorates. Consult us for more details.

### ● PJA100F, PJA150F, PJA300F, PJA600F

- The power supply is designed to handle instant voltage dip but output power derating is necessary.
  - Use Conditions

Maximum output power *( ) is 5V output model.	
PJA100F	40W
PJA150F	60W
PJA300F	120W(100W)
PJA600F	240W(200W)
Input AC50V	
Duty 1s/30s	

\*Avoid using the power supply under the above-mentioned conditions for more than 1 second continuously as the power supply may be damaged.

## 1.2 Inrush Current Limiting

- Inrush current protection is built-in.
- If you need to use a switch on the input side, select one that can withstand an input inrush current.

### ● PJA100F, PJA150F, PJA300F

- Thermistor is used in the inrush current limiting circuit. When you turn the power supply on and off repeatedly within a short period of time, have enough intervals for the power supply to cool down before being turned on again.

### ● PJA600F, PJA1000F, PJA1500F

- Thyristor and TRIAC technique is used in the inrush current limiting circuit. When you turn the power supply on and off repeatedly within a short period of time, have enough intervals for the inrush current protection to become active.
- There will be primary inrush current and secondary inrush current flowing because thyristor and TRIAC technique is used for the inrush current limiting circuit.

## 1.3 Overcurrent Protection

- Overcurrent protection is built-in. It works at more than 105% of the rated output current. The power supply recovers automatically when the overcurrent condition is removed. Do not use the power supply under a short-circuit or overcurrent condition.
- Intermittent Operation Mode  
When overcurrent protection works and the output voltage drops, the output voltage goes into intermittent mode so that the average output current can decrease.

## 1.4 Overvoltage Protection

- Overvoltage protection is built-in. If overvoltage protection works, shut down the input voltage, wait more than 3 minutes, and turn on the input voltage again to recover the output voltage. The recovery time varies depending on the input voltage, etc.

### Remarks :

Avoid applying an overrated voltage to the output terminals as it may cause the power supply to malfunction or fail. In case the above-mentioned situation is expected in operating such loads as a motor, for example, consult us for advice.

## 1.5 Thermal Protection

### ● PJA100F, PJA150F

- These models are not equipped with thermal protection.

### ● PJA300F, PJA600F, PJA1000F, PJA1500F

- Thermal protection is built-in.  
Thermal protection will work under the following conditions and the power supply will shut down.
  - ① When the operating temperature and the output current greatly exceed the derating curve.
  - ② When the built-in cooling fan stops or the air flow from the fan is obstructed.
 If thermal protection works, switch off the input voltage and eliminate the conditions causing thermal protection to work. Allow enough time for the unit to cool off before switching on the input voltage again to recover the output voltage.

### 1.6 Output Ripple and Ripple Noise

■Output ripple noise may be influenced by the measuring environment. The measuring method shown in Fig. 1.1 is recommended.

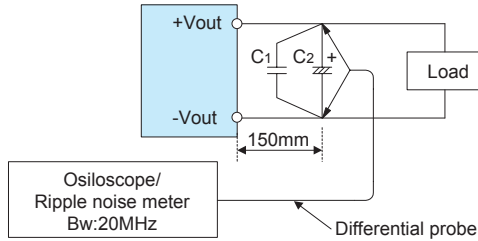

C1: Film capacitor 0.1µF  
C2: Aluminum electrolytic capacitor 22µF

Fig.1.1 Measuring method of Ripple and Ripple Noise

**Remarks :**

When measuring output ripple or ripple noise with an oscilloscope, do not let the oscilloscope's GND cable cross the magnetic flux from the power supply. Otherwise there may be electrical potential generated on the GND cable and the measuring result may not be accurate.

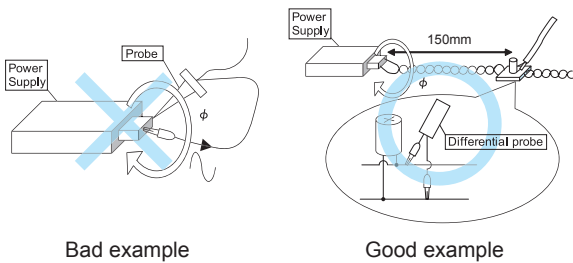

Fig.1.2 Example of measuring output ripple and ripple noise

### 1.7 Output Voltage Adjustment

- The output voltage can be adjusted within the specified range by turning the built-in potentiometer clockwise (up) or counterclockwise (down).
- Please operate the potentiometer slowly.

● **PJA600F**

■With the option -V, the power supply comes with an external potentiometer instead of a built-in potentiometer. (See 5 Options and Others).

### 1.8 Isolation

■For a receiving inspection, such as Hi-Pot test, gradually increase (decrease) the voltage for the start (shut down). Avoid using Hi-Pot tester with the timer because it may generate voltage a few times higher than the applied voltage, at ON/OFF of a timer.

### 1.9 Low Power Consumption

● **PJA100F, PJA150F**

- These power supplies are designed for low power consumption at no load. (No load power consumption: 1.5W typ)
- When the load factor is 0- 30%, the switching power loss is reduced by burst operation, which will cause ripple and ripple noise to go beyond the specifications.
- Ripple and ripple noise during burst operation will change depending on the input voltage and the output current. Consult us for advice on how to reduce ripple and ripple noise.
- When there is a need to measure the stand-by power consumption, measure it by using the average mode of the tester. The measuring environment may influence the result. Consult us for more details.

### 1.10 Remote ON/OFF

■The -R option is available for these models. With the -R option, remote ON/OFF is possible. See "5 Options and Others" for more details.

### 1.11 Remote Sensing

● **PJA100F, PJA150F, PJA300F**

■These models do not have the remote sensing function.

● **PJA600F**

■The -W option is available. With the -W option, remote sensing is possible. See "5 Options and Others" for more details.

### 1.12 LV Alarm

● **PJA100F, PJA150F, PJA300F**

■These models do not have the LV alarm function.

● **PJA600F**

■The -W option is available. With the -W option, the power supply can give an LV alarm. See "5 Options and Others" for more details.

## 2 Series Operation and Parallel Operation

### 2.1 Series Operation

■ The power supplies can be used in series connection. The output current in series operation must be lower than the rated current of the power supply with the lowest rated current among the power supplies connected in series. Make sure no current exceeding the rated current flows into a power supply.

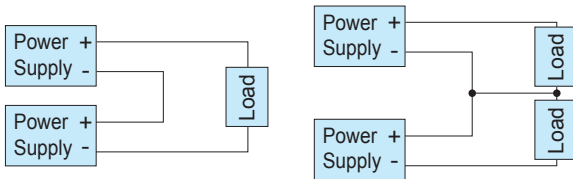

Fig.2.1 Examples of connecting in series operation

### 2.2 Parallel Operation

■ Redundant operation is possible by wiring as shown below.

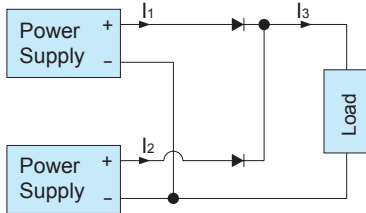

Fig.2.2 Example of redundancy operation

■ Even a slight difference in output voltage can affect the balance between the values of  $I_1$  and  $I_2$ .

Make sure the value of  $I_3$  does not exceed the rated output current of the power supply.

$$I_3 \leq \text{the rated current value}$$

#### ● PJA100F, PJA150F, PJA300F

■ Parallel operation is not possible.

#### ● PJA600F

■ The -W option is available. With the -W option, parallel operation is possible. See "5 Options and Others" for more details.

## 3 Assembling and Installation Method

### 3.1 Installation Method

■ Do not insert a screw more than 6mm away from the outside of a power supply to keep enough insulation distance between the

screw and internal components.

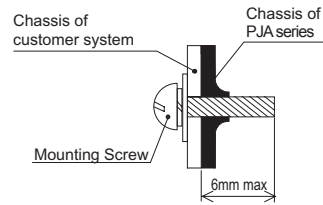

Fig.3.1 Mounting screw

#### ● PJA100F, PJA150F

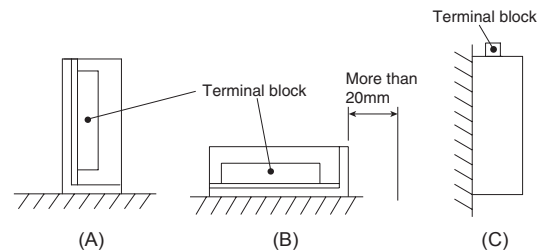

Fig.3.2 Installation method (PJA100F/PJA150F)

■ If you use two or more power supplies side by side, please keep a sufficient distance between them to allow enough air ventilation.

■ Ambient temperature around each power supply should not exceed the temperature range shown in the derating curve.

#### ● PJA300F

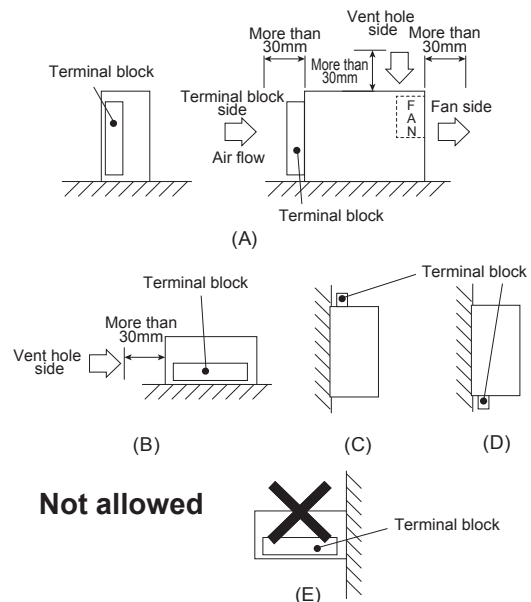

Fig.3.3 Installation method (PJA300F)

● PJA600F

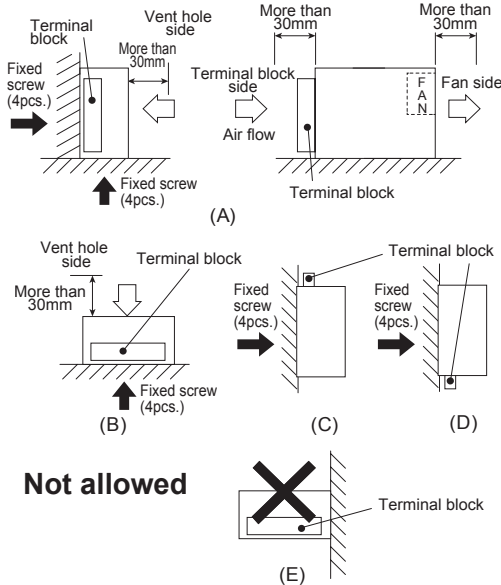

Fig.3.4 Installation method (PJA600F)

● PJA1000F, PJA1500F

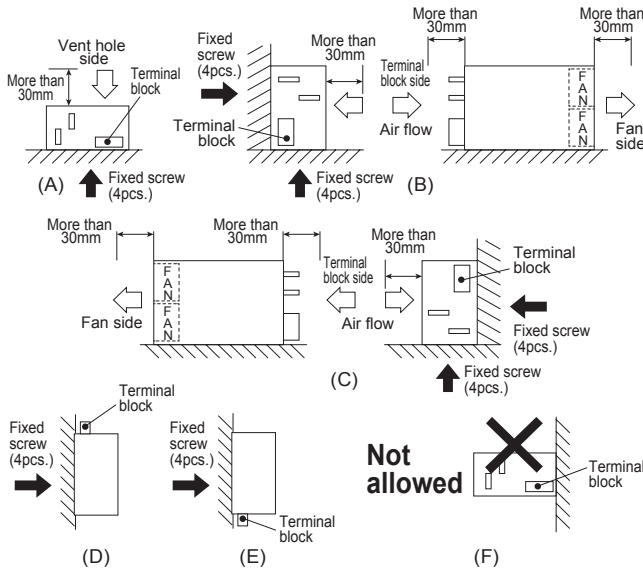

Fig.3.5 Installation method (PJA1000F/PJA1500F)

- When mounting the power supply with screws, it is recommended that this be done as shown in Fig.3.3 - Fig.3.5. If other methods are used, be sure the weight of the power supply is taken into account.
- Avoid the not allowed installation method as it gives excessive stress to the mounting holes.
- Do not block air flow of the built-in fan (terminal block and ventilation hole).
- If the power supply is used in a dusty environment, use an air-filter. Make sure air flow is not blocked.
- If the built-in fan stops, thermal protection will work and the output will stop.

■ The expected life (R(t)=90%) of the built-in fan varies depending on the operating condition.

3.2 Derating

■ Input Voltage Derating Curve

The input voltage derating curve is shown in Fig. 3.6.

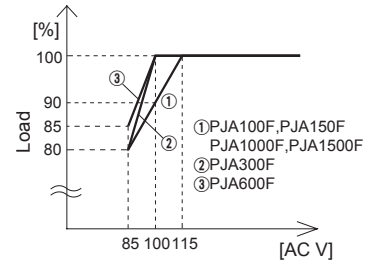

Fig.3.6 Input voltage derating curve

■ Ambient Temperature Derating Curve

The derating curves by the ambient temperature are shown in Fig. 3.7 - Fig. 3.10.

\* The specifications of ripple and ripple noise change in the shaded area.

(1) Temperature at Point A and Point B

● PJA100F, PJA150F

■ Make sure the case temperature at point A and point B is less than the temperatures shown in Table 3.1 and Table 3.2.

■ When the power supply is used with a forced cooling, make sure the case temperature requirements shown in Table 3.1 and Table 3.2 are met.

■ The expected life of the power supply at the highest allowed temperature at point A and point B is 3 years. See “3.3 Expected Life and Warranty” to prolong the expected life.

See External View for the position of Point A and Point B.

Table 3.1 Temperature of Point A PJA100F-□

Mounting Method	Load factor	Max temperature [°C]
A, B, C	$I_o \leq 100\%$	81

Table 3.2 Temperature of Point A, Point B PJA150F-□

Mounting Method	Load factor	Max temperature [°C]	
		Point A	Point B
A, B, C	$I_o \leq 100\%$	85	78

(2) Derating Curves by Ambient Temperature

● PJA100F, PJA150F

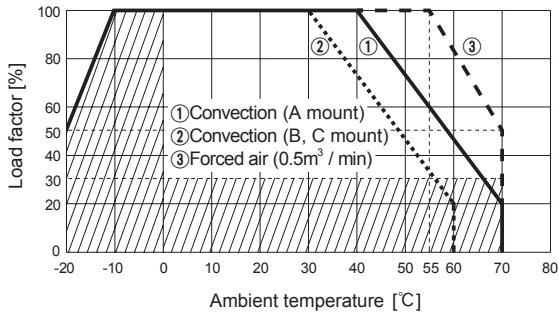

Fig.3.7 Ambient temperature derating curve for PJA100F/150F-12, -15

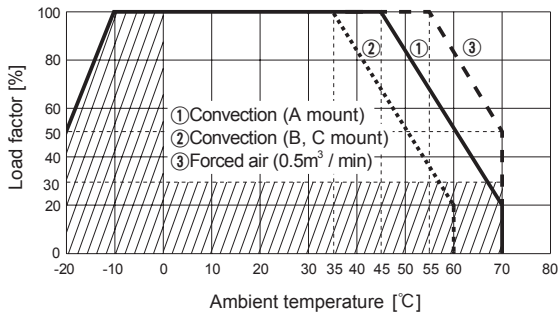

Fig.3.8 Ambient temperature derating curve for PJA100F/150F-24, -36, -48

■ The ambient temperature should be measured 5 to 10 cm away from the power supply so that it won't be influenced by the heat from the power supply. Please consult us for more details.

● PJA300F

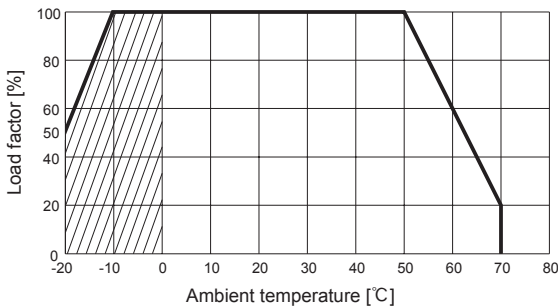

Fig.3.9 Ambient temperature derating curve for PJA300F

● PJA600F, PJA1000F, PJA1500F

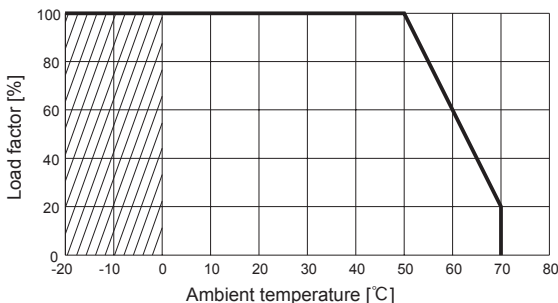

Fig.3.10 Ambient temperature derating curve for PJA600F/PJA1000F/PJA1500F

■ The ambient temperature is defined as the temperature of the air (at the terminal block side) that the built-in cooling fan blows into the power supply. Please pay attention to the heat generated by the input and output wires. Please consult us for more details.

3.3 Expected Life and Warranty

■ Expected Life

The expected life of the power supply is shown below.

● PJA100F, PJA150F

Table 3.3 Expected lifetime (PJA100F/PJA150F)

Mounting Method	Cooling Method	Average ambient temperature	Expected lifetime [years]	
			l <sub>o</sub> ≤ 50%	l <sub>o</sub> ≤ 100%
A	Convection	Ta = 30°C	10	5
		Ta = 40°C	5	3
B, C	Convection	Ta = 20°C	10	5
		Ta = 30°C	5	3
A, B, C	Forced air cooling	Ta = 40°C	10	5
		Ta = 55°C	5	3

● PJA300F, PJA600F, PJA1000F, PJA1500F

Table 3.4 Expected lifetime (PJA300F/PJA600F/PJA1000F/PJA1500F)

Mounting	Cooling method	Average ambient temperature	Expected lifetime [years]	
			l <sub>o</sub> ≤ 50%	l <sub>o</sub> ≤ 100%
All direction	Forced air cooling (internal fan)	Ta = 30°C	10	7
		Ta = 40°C	7	5
		Ta = 50°C	5	3

\* This lifetime includes a built-in fan lifetime.

■ The expected life time (R (t) = 90%) of the built-in fan depends on the operating condition as shown in Fig. 3.11, 3.12.

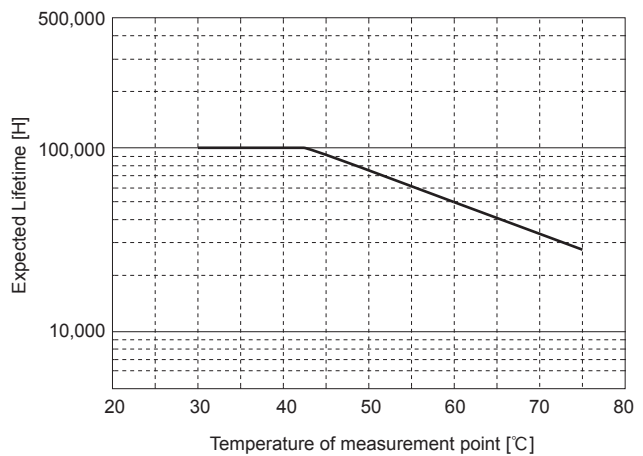

Fig.3.11 Expected lifetime of fan (PJA300F/PJA600F)

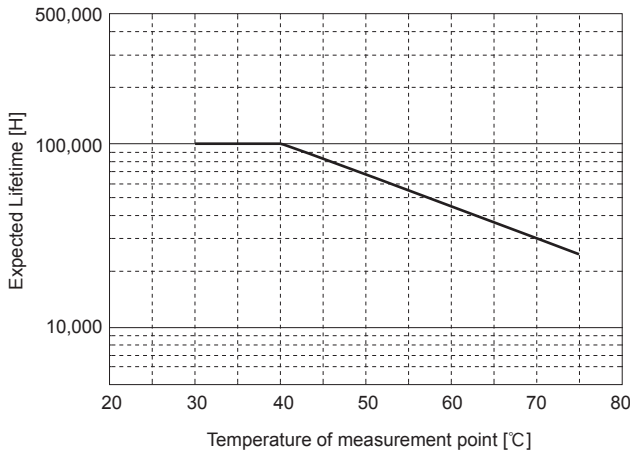

Fig.3.12 Expected lifetime of fan (PJA1000F/PJA1500F)

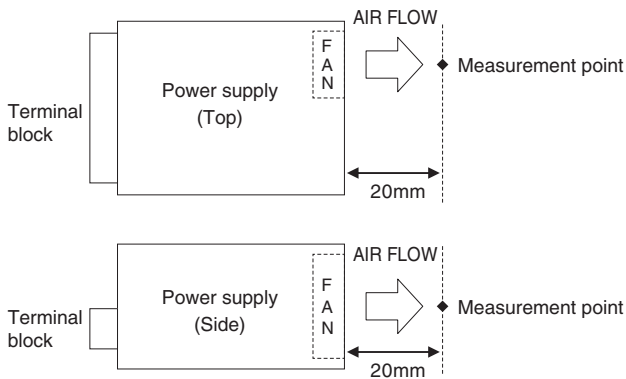

Fig.3.13 Temperature of measurement point for fan lifetime (PJA300F/PJA600F)

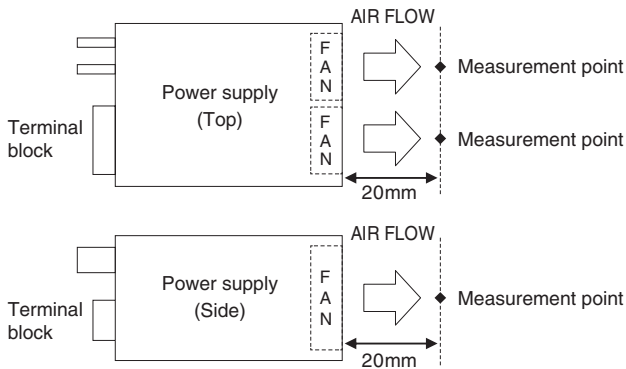

Fig.3.14 Temperature of measurement point for fan lifetime (PJA1000F/PJA1500F)

■Warranty

The maximum warranty period is 5 years as shown in Table 3.5, 3.6.

Table 3.5 Warranty (PJA100F/PJA150F)

Mounting	Cooling method	Average ambient temperature	Warranty [years]	
			Io ≤ 50%	Io ≤ 100%
A	Convection	Ta = 30°C	5	5
		Ta = 40°C	5	3
B, C	Convection	Ta = 20°C	5	5
		Ta = 30°C	5	3
A, B, C	Forced air cooling	Ta = 40°C	5	5
		Ta = 55°C	5	3

● PJA300F, PJA600F, PJA1000F, PJA1500F

Table 3.6 Warranty (PJA300F/PJA600F/PJA1000F/PJA1500F)

Mounting	Cooling method	Average ambient temperature	Warranty [years]	
			Io ≤ 50%	Io ≤ 100%
All direction	Forced air cooling (internal fan)	Ta = 40°C	5	5
		Ta = 50°C	5	3

## 4 Ground

■When installing the power supply, make sure the FG terminal and the chassis (at more than 2 places) are connected to the safety earth ground.

## 5 Options and Others

### 5.1 Outline of Options

● -C (PJA100F, PJA150F, PJA600F)

· With the -C option, the internal PCB has a conformal coating for anti-humidity.

● -G (PJA600F)

· With the -G option, the leakage current of the power supply is reduced.  
 · The differences between the option -G models and the standard models are shown below.

Table 5.1 Low leakage current type

Leakage Current (AC240V 60Hz)	0.15mA max
Conducted Noise	N/A
Output Ripple Noise	Please contact us for details about Ripple Noise

\* This is the result of measurement of the testing board with capacitors of 22μF and 0.1μF placed at 150 mm from the output terminals by a 20 MHz oscilloscope or a ripple-noise meter equivalent to Keisoku-Giken RM103.

● -V (PJA600F)

· With the -V option, the power supply comes with an external potentiometer connector instead of a built-in potentiometer.  
 · The appearance of the -V models is different from that of the standard models. Contact us for more details.  
 · Note that if the power supply is turned on with CN3 open, the output voltage will make a big drop.



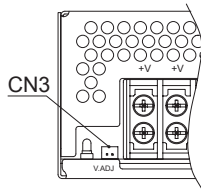

Fig.5.1 Front view of option-V (PJA600F)

## ● -R (PJA100F, PJA150F, PJA600F)

- The -R option makes it possible to switch on or off the output by applying voltage to the RC terminals of the power supply from an external power source.
- The appearance of the option -R models is different from that of the standard models.
- Designated harnesses for the RC terminals are available for sale. See Optional Parts for more details.
- The -R option models have extra connectors. Please contact us for more details.

Table 5.2 Remote on/off operating conditions

Model Name	Built-in Resistor Ri [Ω]	Voltage between RC and RCG [V]		Input Current [mA]
		Output ON	Output OFF	
PJA100F, PJA150F, PJA600F	780	4.5 - 12.5	0 - 0.5	(20max)

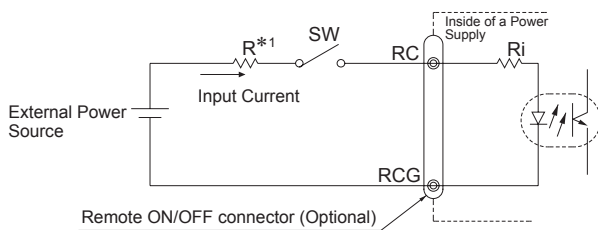

Fig.5.2 Example of using a remote ON/OFF circuit

- \* 1 If the external voltage applied to the RC terminals is 4.5 - 12.5V, the current limiting resistor is not necessary. If the voltage applied is more than 12.5V, make sure the current limiting resistor R is used.

The value of the current limiting resistor is obtained by the following formula:

$$R[\Omega] = \frac{V_{cc} - (1.1 + R_i \times 0.005)}{0.005} \quad V_{cc} : \text{External Power Source}$$

- \* Note that reversed connection damages internal components of the power supply.
- \* The remote control circuit is isolated from input, output and FG.

## ■ Remote on/off control for PJA100F, PJA150F

- Remote control connectors are added. Contact us for more details.
- Make sure there is an interval of more than 2 seconds in the on/off cycle. If the interval is shorter, the start-up time may become longer (approx. 2 seconds).

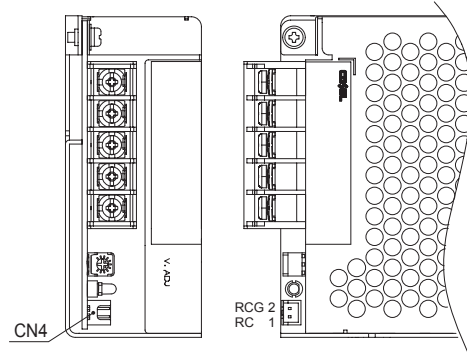

Fig.5.3 Example of option -R

Table 5.3 Pin configuration and function of CN4

PIN	FUNCTION
1	RC :Remote ON/OFF
2	RCG:Remote ON/OFF (GND)

Table 5.4 Mating connectors and terminals on CN4

Connector	Housing	Terminal	Mfr
CN4	B2B-XH-AM	XHP-2	BXH-001T-P0.6
			or SXH-001T-P0.6
			J.S.T.

## ■ Remote on/off control for PJA600F

- The appearance of the -R option model is different from that of the standard model as CN1 is added. Contact us for more details.

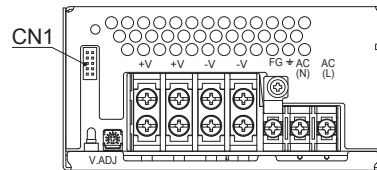

Fig.5.4 Front view of option -R (PJA600F)

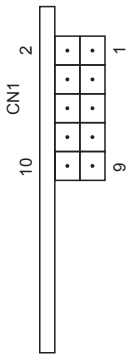

Fig.5.5 Pin number

Table 5.5 Pin configuration and function of CN1

PIN	FUNCTION
1	- :N.C.
2	- :N.C.
3	RC :Remote ON/OFF
4	RCG:Remote ON/OFF(GND)
5	- :N.C.
6	- :N.C.
7	- :N.C.
8	- :N.C.
9	- :N.C.
10	- :N.C.

Table 5.6 Mating connectors and terminals on CN1

Connector	Housing	Terminal	Mfr
CN1	S10B-PHDSS	PHDR-10VS	Reel :SPHD-002T-P0.5
			Loose :BPHD-001T-P0.5
			:BPHD-002T-P0.5
			J.S.T.

● -W (PJA600F)

- The -W option model provides remote sensing, low output voltage alarm (LV alarm), and parallel operation.
- The appearance of the -W option model is different from that of the standard mode. Contact us for more details.
- Designated harnesses are available for sale. See Optional Parts.
- The differences from the standard model are shown in Table 5.7.

Table 5.7 Specification differences of Option -W

Load regulation	1.5 times of standard spec.
Ripple	1.5 times of standard spec.
Ripple noise	1.5 times of standard spec.

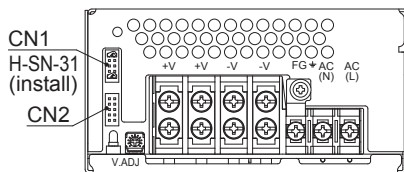

Fig.5.6 Front view of option -W (PJA600F)

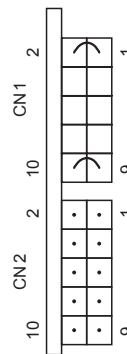

Fig.5.7 Pin number

Table 5.8 Pin configuration and function of CN1 and CN2

PIN	FUNCTION
1	+M :Self sensing terminal (Don't wire for external function)
2	+S :+Sensing
3	- :N.C.
4	- :N.C.
5	LV :LV alarm
6	LVG :LV alarm (GND)
7	CB :Current balance
8	- :N.C.
9	-M :Self sensing terminal (Don't wire for external function)
10	-S :-Sensing

Table 5.9 Mating connectors and terminals on CN1 and CN2

Connector	Housing	Terminal	Mfr
CN1 CN2	S10B-PHDSS	PHDR-10VS	Reel :SPHD-002T-P0.5
			Loose :BPHD-001T-P0.5
			:BPHD-002T-P0.5
			J.S.T.

■ LV alarm

The operating conditions of the LV alarm are shown in Table 5.10. The internal circuit of the LV alarm is shown in Fig. 5.11. The LV alarm is isolated from input, output, and FG.

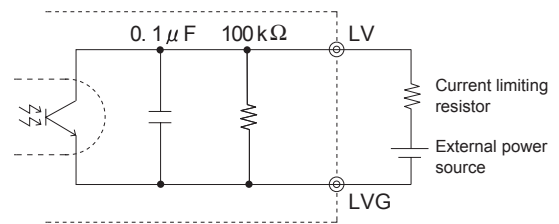

Fig.5.8 LV internal circuit

Table 5.10 LV alarm operating conditions

	Alarm	Output of alarm
LV	If the output voltage drops or stops, the LV and LVG terminals give an alarm signal. Note : ①In case of overcurrent, the alarm signal will be unstable. ②The alarm signal won't be given in parallel operation if OR diodes are not used.	Open collector method Good : Low (0 - 0.8V, 10mA max) Fail : High or Open 50V 10mA max

■ Parallel operation

For parallel operation, please take the following steps:

- ① (Before wiring) set the output voltage of each unit to the desired value. The output voltage difference between the units must be less than 0.1V or 1% of the rated output voltage, whichever is smaller.
- ② Wire the power supplies as shown in Fig. 5.9. Make sure the output wires of the units connected in parallel are of the same length and the same type.
- ③ Make sure the total output current does not exceed the value determined by the following formula:

$$\left[ \begin{array}{l} \text{Output current in} \\ \text{parallel operation} \end{array} \right] = \left[ \begin{array}{l} \text{The rated} \\ \text{current per unit} \end{array} \right] \times (\text{Number of unit}) \times 0.85$$

- \* Make sure the current drawn from each unit is less than the rated output current.
- When adjusting the output voltage after wiring, repeat the above-mentioned steps (① to ③).
- If the number of units in parallel increases, the input current increases as well. Make sure the input equipment and wires have enough current capacity.
- The maximum number of units for parallel connection is 5.
- Master-Slave operation is not possible.

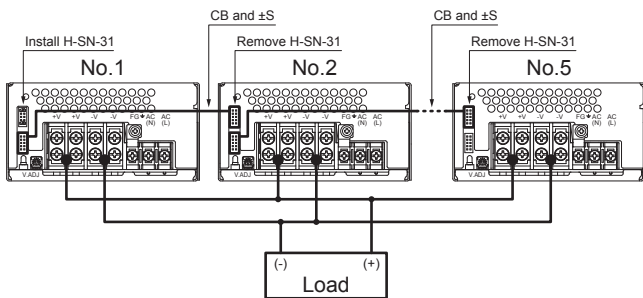

Fig.5.9 Parallel operation condition

- If the output current is less than 10% of the rated output current, the output voltage may fluctuate. The required minimum current is different depending on the model and the number of units in parallel. Consult us for more details.
- If the length of the output wires of each unit is different, the output current from each unit will be unbalanced. Make sure to use output wires of the same length for all units in parallel.

### Remote sensing

- These models are equipped with a remote sensing function. If the remote sensing is not used, the following terminals of CN1 must be shorted:

- +S and +M
- S and -M

When the power supply is shipped from our factory, a designated harness (H-SN-31) is attached to CN1. If remote sensing is not used, there is no need to remove the harness.

- The wire connection when remote sensing is used or not used is shown in Fig. 5.10 - Fig. 5.11.
- When using remote sensing, make sure to finish wiring +S and -S first. The designated harness is available for sale. Contact us for more details.
- When using remote sensing, pay attention to the following:
  - ① Wiring must be done carefully. If there is bad connection on the load lines due to loose screws, etc., the load current flows into the sensing lines and the internal circuit of the power supply may be damaged.
  - ② Make sure the wires between the load and the power supply are thick enough to keep the line drop less than 0.3V.
  - ③ If the sensing wires are long, place C1 and R1 across the load lines.
  - ④ Use a twisted pair wire or a shielded wire for the sensing lines.
  - ⑤ Do not draw the output current from +M, -M, +S or -S.

- ⑥ The impedance of the wiring or the load may cause the output voltage to oscillate or fluctuate.

Test to confirm remote sensing works fine. If the output voltage is found to be unstable, the following methods are recommended:

- Remove the remote sensing line on the minus side and short -S and -M.
- Use C1, R1, and R2.

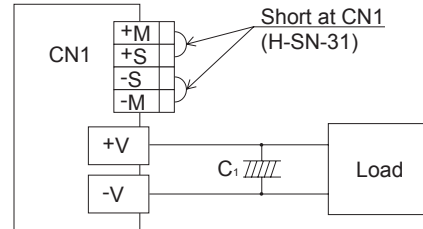

Fig.5.10 When not using remote sensing function

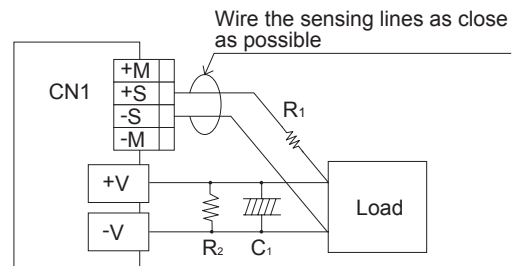

Fig.5.11 When using remote sensing function

## ● -T (PJA100F, PJA150F)

- The -T option models come with a vertical terminal block. The appearance is different from that of the standard models. Contact us for more details.

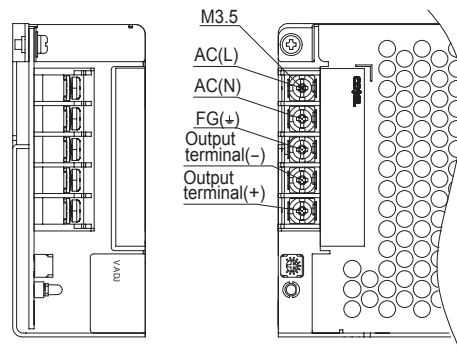

Fig.5.12 Example of option -T(PJA100F)

● -J (PJA100F, PJA150F)

- The -J option models come with AMP connectors instead of a terminal block.
- The designated harnesses are available for sale. See Optional Parts for more details.
- The appearance is different from that of the standard models. Contact us for more details.
- Keep the drawing current less than 5A per pin.
- UL508 does not apply to the -J option models.

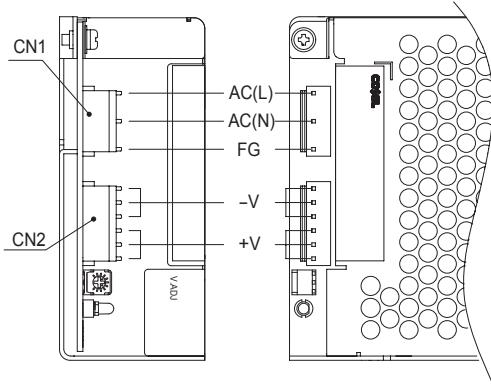

Fig.5.13 Example of option -J (PJA100F)

Table 5.11 Mating connectors and terminals on CN1 and CN2 in option -J (PJA100F, PJA150F)

I/O Connector		Matching Housing	Terminal
CN1	1-1123724-3	1-1123722-5	Reel : 1123721-1
			Loose : 1318912-1
CN2	1-1123723-6	1-1123722-6	Reel : 1123721-1
			Loose : 1318912-1

(Mfr. Tyco electronics AMP)

● -F4 (PJA600F)

- The -F4 option models come with a low-speed fan to reduce the fan noise.
- The differences from the standard fan versions are shown below.

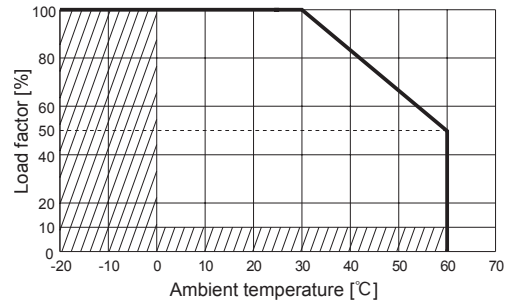

Fig.5.14 Ambient temperature derating curve for PJA600F (Option-F4)

\*The specification of ripple and ripple noise changes in shaded area.

Table 5.12 Expected lifetime (-F4)

Mounting	Cooling method	Average ambient temperature	Expected lifetime [years]	
			$I_o \leq 50\%$	$I_o \leq 100\%$
All direction	Forced air cooling (internal fan)	Ta = 10°C	10	7
		Ta = 20°C	7	5
		Ta = 30°C	5	3

\*This lifetime includes a built-in fan lifetime.

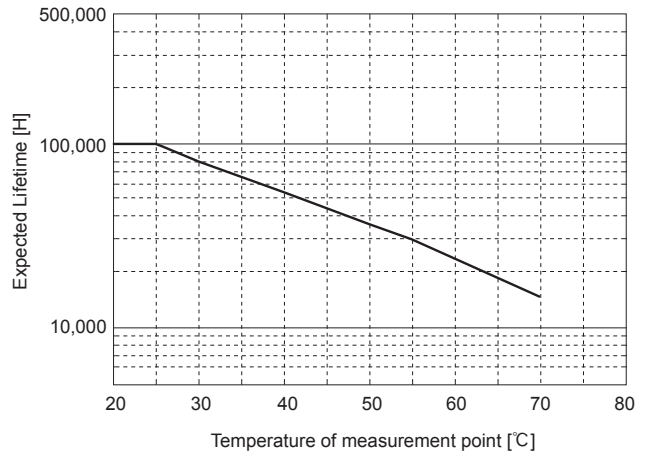

Fig.5.15 Expected lifetime of fan R(t)=90% (-F4)

Table 5.13 Warranty (-F4)

Mounting	Cooling method	Average ambient temperature	Warranty [years]	
			$I_o \leq 50\%$	$I_o \leq 100\%$
All direction	Forced air cooling (internal fan)	Ta = 20°C	5	5
		Ta = 30°C	5	3

● **-N2 (PJA100F, PJA150F)**

- The -N2 option models come with a DIN rail mount attachment.
- The appearance is different from that of the standard models. Contact us for more details.
- The -N2 option models have different vibration and shock specifications. Consult us for more details.
- Contact us for safety agency approvals.

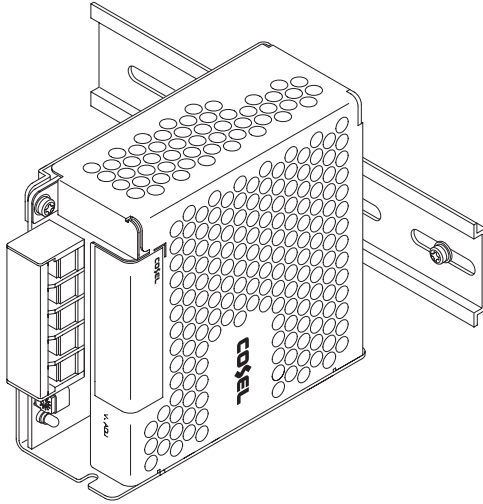

Fig.5.16 Power supply installed on a DIN rail (PJA100F)

## 5.2 Others

- Note that the case of the power supply remains hot for a while after it is turned off.
- If large capacitors are connected to the output terminals (load side), the output voltage may stop or become unstable. Consult us for advice.
- If the power supply is turned off at no load, the output voltage remains for a few minutes as the power supply is designed for low internal power consumption. Be careful of electrical shock at the time of maintenance.
- If the built-in cooling fan in PJA300F, PJA600F, PJA1000F and PJA1500F stops, the built-in thermal protection may work and the output voltage may stop. Please check fan rotation periodically, to enhance the system reliability.